



Technical Data

Specification & Capacities

SPX532

OVERALL DIMENSIONS SPX532CDH JIB STOWED

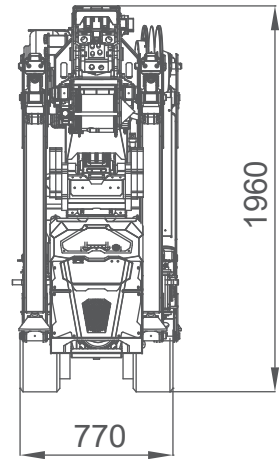
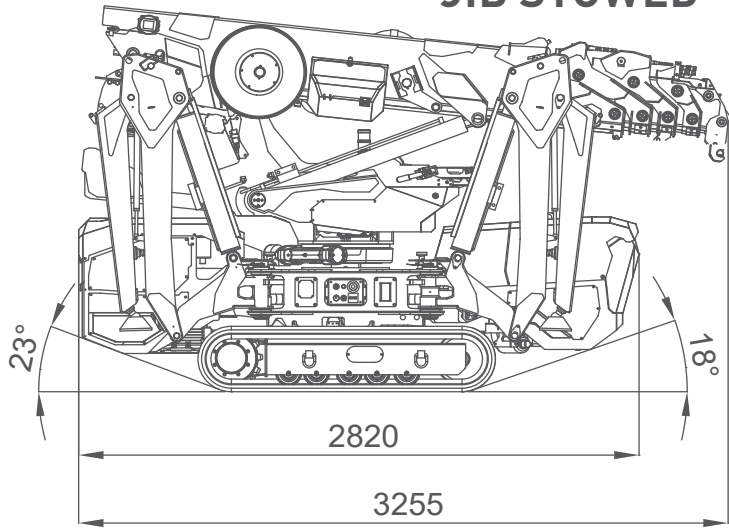

JIB MOUNTED

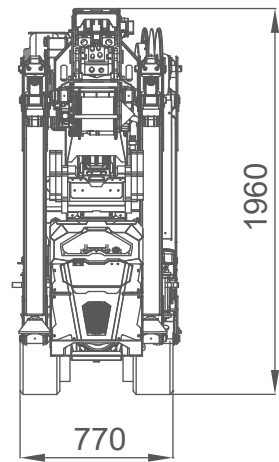
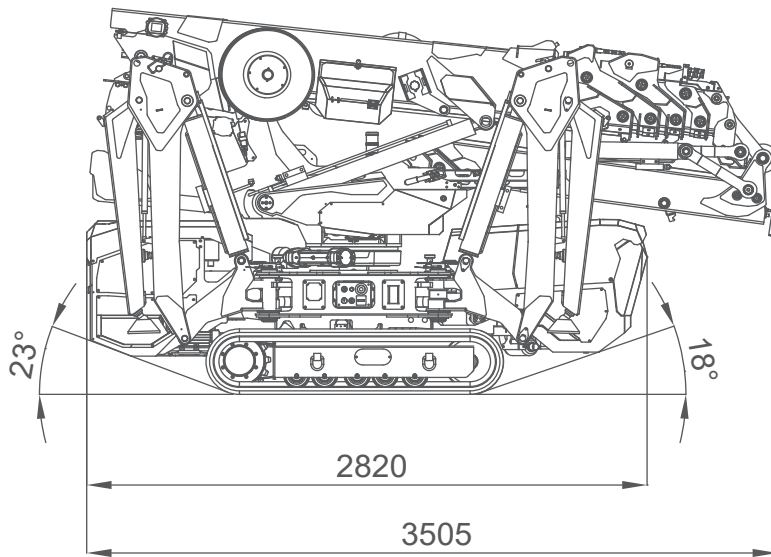

EXTENDED TRACKS

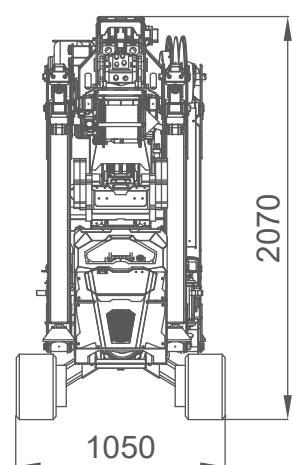
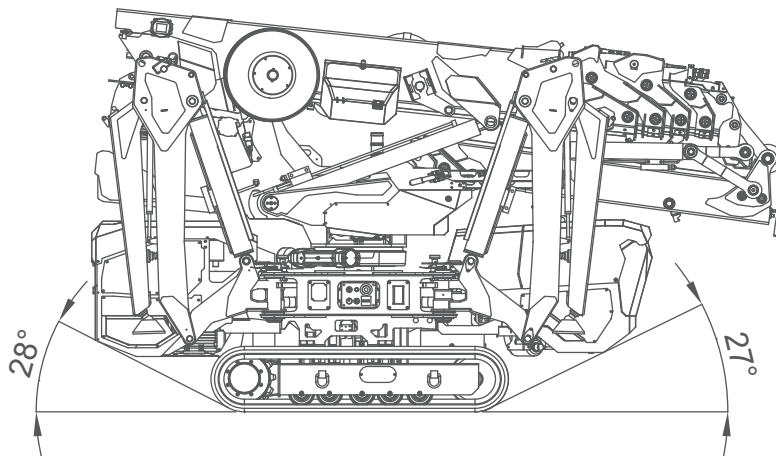



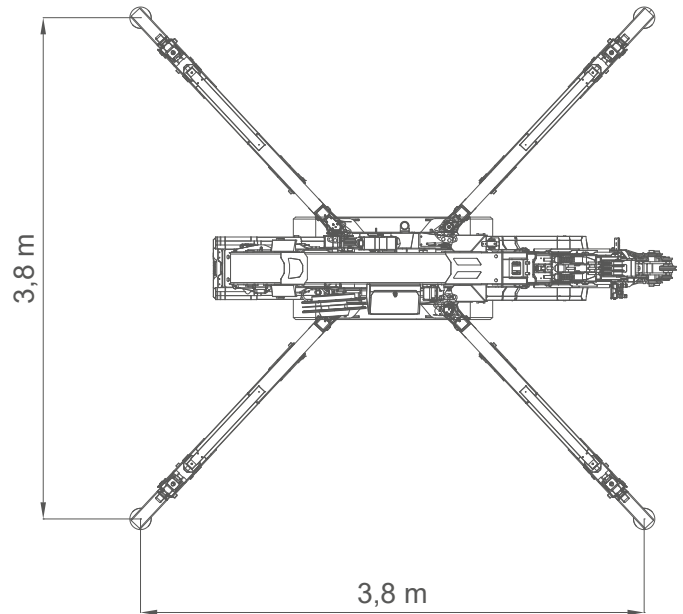
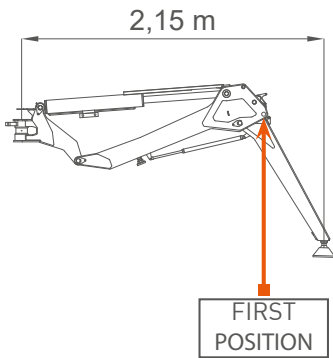

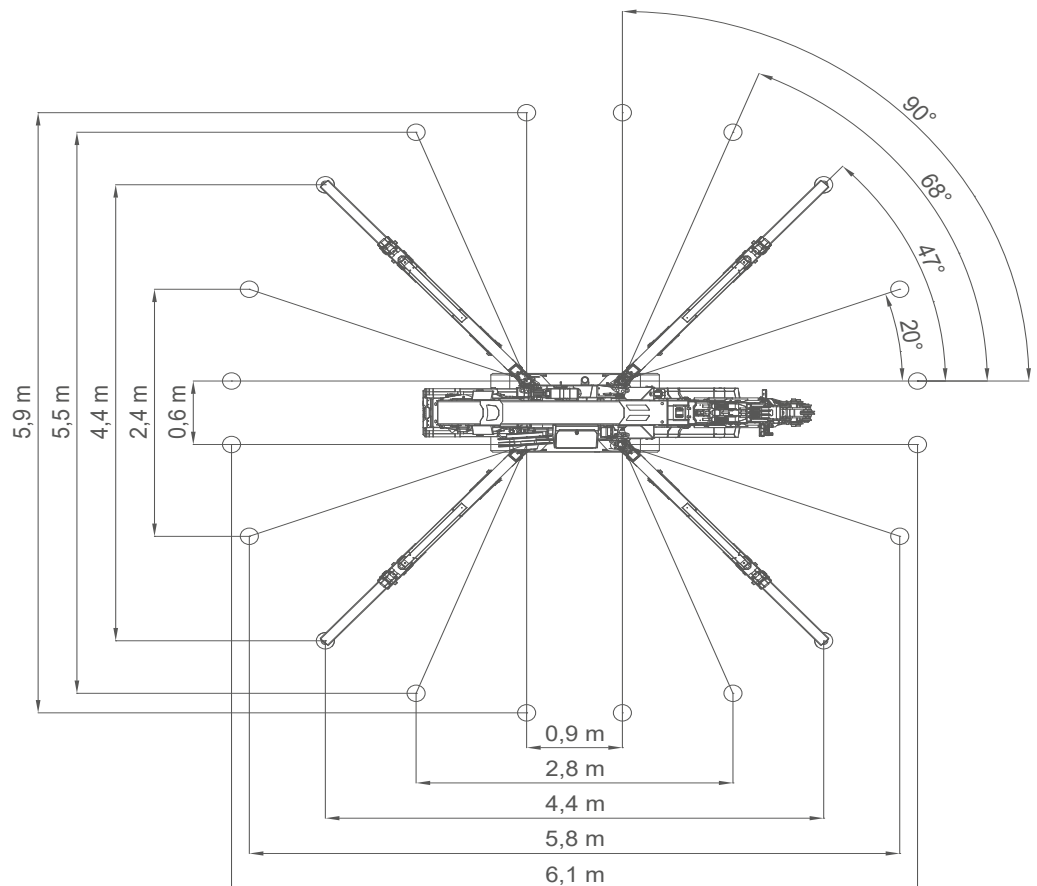
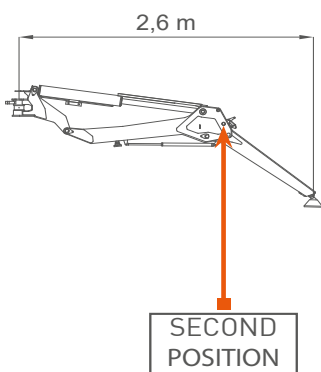

OVERALL DIMENSIONS SQUARE OUTFRIGGER 1ST POSITION STABILITY















OUTRIGGER 2ND POSITION FULL STABILITY



OVERALL INFORMATION

		Name/ version	kg*
WEIGHTS	 Crane	CDH, CL, CL2	2520
	 Winch	W800.6	52
	 Hookblock	SINGLE FALL	20
		MULTIPLE FALL	49
	 Power Pack	1-PHASE POWERPACK	52
		3-PHASE POWERPACK	63
	 Jib	JIB1200GX	50
		JIB1000.2H1MX	210
		MANUAL EXTENSION	14
		PULLEY HEAD	8
 Outriggers mats	OM400	17	

ENGINE	 Engine	KUBOTA D902-E4B	
	kW Power	16,1kW 22HP	
	 Fuel	DIESEL	
ELECTRIC	 Tank	L	10
	 Lithium Battery	C+: 24V 420Ah	
HYDRAULIC	kW Power	24V-3F 5,5kW 7,5HP	
	 Hydraulic Oil	ISO 6743-4:HFDU with VG46 viscosity class	
		Working temp	<70°C
MOVEMENTS		L	40
	 Travel Speed	km/h	CDH: 2,7 CL, CL2 : 1,8
	 Gradeability	20° (36%) [†]	
	 Track Load	kg/cm ²	0,63
	 Outrigger Load	kg	3000 [‡]
	 Working Angle	0°/80°	
		s	30
	 Slewing	360°	
rpm		0,85	
 Boom Telescoping	m	2,5 - 10,8	
	s	40	

*: Dry weight
 †: Engine working limit
 ‡: Static lifting

HOIST PERFORMANCE

GEAR WINCH	Layer	Max line pull	Standard rope speed	Highest rope speed
		kg	m/min	m/min
	1	785		25
	2	730		27
	3	680		29
	4	640		31
	5	600		33
ROPE	Wire rope	∅	Total lenght	Max load
		mm	m	kg
	19x7 right lang lay Non rotating	7	81	5700
PISTON WINCH	Layer	Max line pull	Standard rope speed	Highest rope speed
		kg	m/min	m/min
	1	980*		16
	2	910*		17
	3	860*		19
	4	810*		20
ROPE	Wire rope	∅	Total lenght	Max load
		mm	m	kg
	19x7 right lang lay Non rotating	7	68	5700
HOOK BLOCK	Load	N° of		Block type
	kg	Sheaves	Lines	
	3200	2	4	Multiple fall block
	2400	1	3	
	1600	1	2	
	800	-	1	Single fall block

*: LMI limited at 800 kg

PULLEY HEAD AND HOOKBLOCK

TILTING PULLEY HEAD

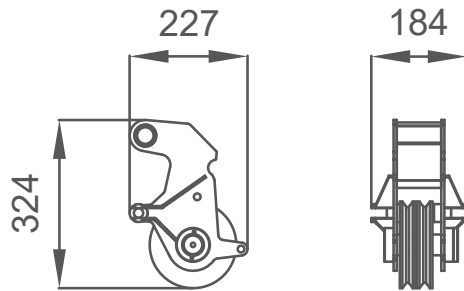

SINGLE FALL

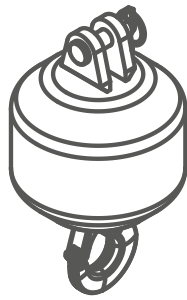

MULTIPLE FALLS

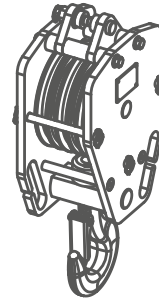

CRANE PERFORMANCE

		d			
		1,1 m	1,8 m	2,2m	
CRANE PERFORMANCE	J7				
	J6				
	J5				
	J4				
	J3				
	J2				
	J1	PICK & CARRY			
	J0	No LIFTING CAPACITY			
			2,2 x 2,2 m	3,6 x 3,6 m	4,4 x 4,4 m
	STABILITY AREA				

STABILITY EXAMPLES

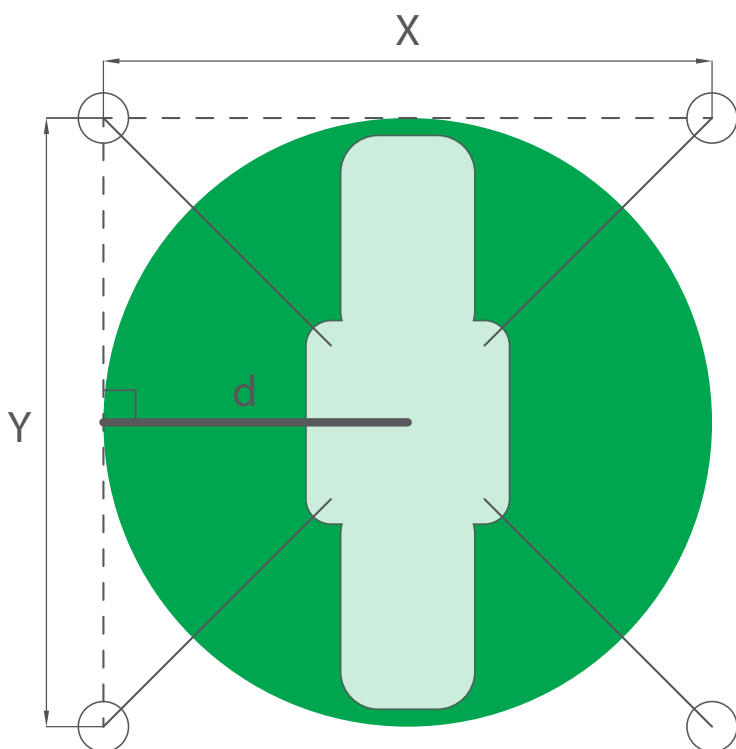

Example 1:
Square stability area.

$X = 4,4 \text{ m}$
 $Y = 4,4 \text{ m}$
 $d = 2,2 \text{ m}$

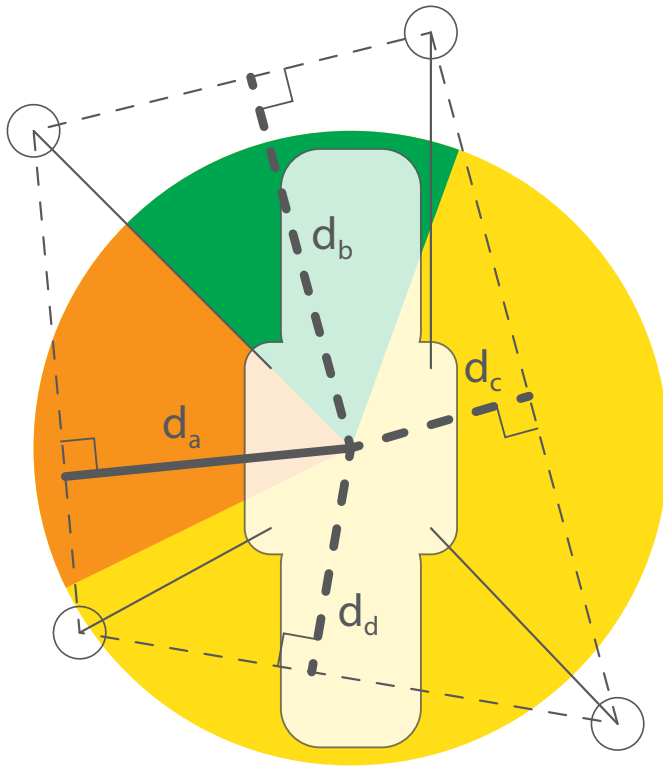

Example 2:
Asymmetric stability area.

$d_a = 1,9 \text{ m}$
 $d_b = 2,2 \text{ m}$
 $d_c = 1,3 \text{ m}$
 $d_d = 1,3 \text{ m}$

Example 3:
Close outriggers stability area.

$X = 0,6 \text{ m}$
 $Y = 5,0 \text{ m}$
 $d_a = 0,3 \text{ m}$
 $d_b = 2,5 \text{ m}$
 $d_c = 0,3 \text{ m}$
 $d_d = 2,5 \text{ m}$

d_b and d_d should be J7 geometrically but is limited to J0 anyway because too narrow.

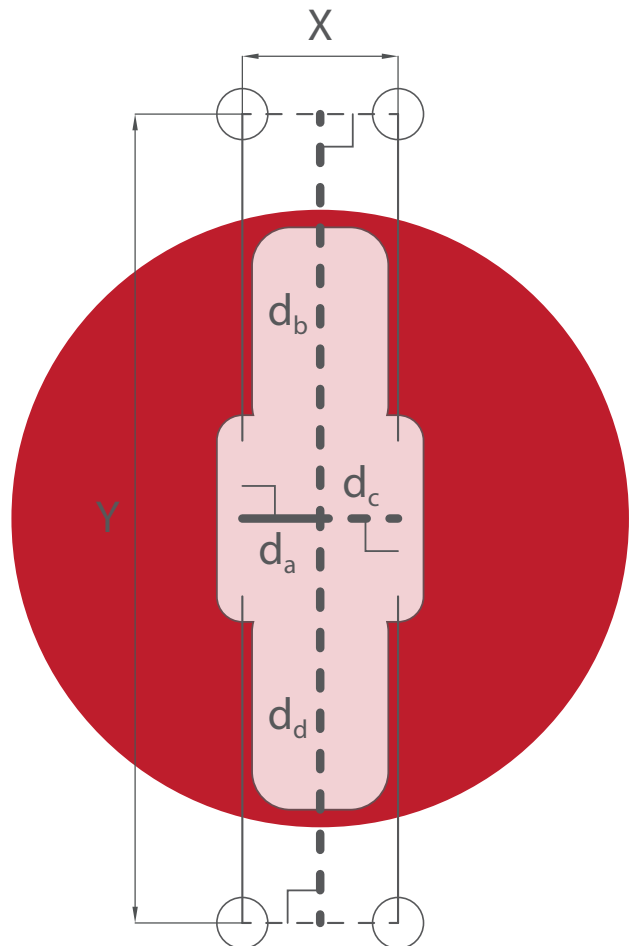

SPX532 - MAIN BOOM

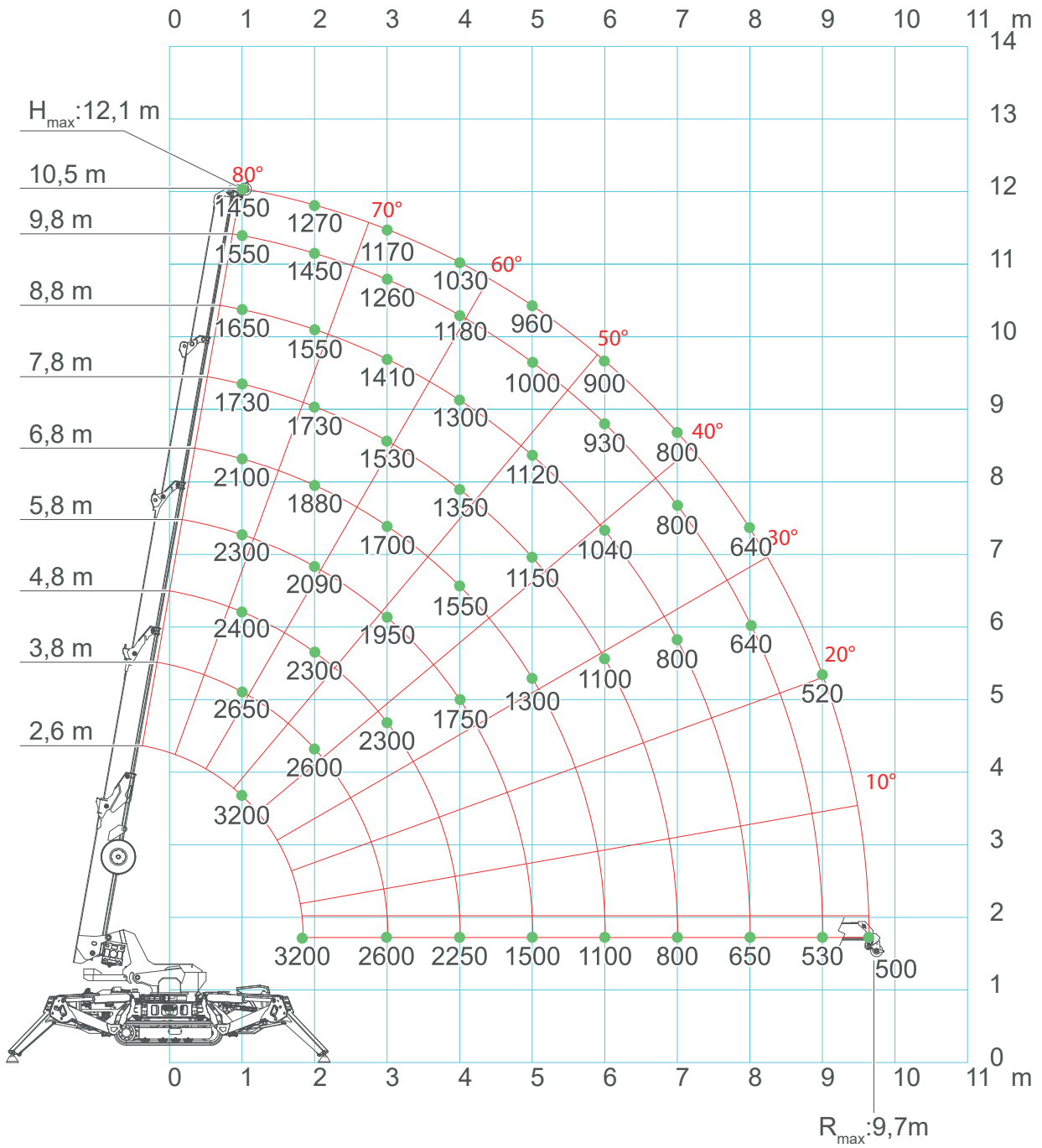

SPX532 - MAIN BOOM

CRANE PERFORMANCE: J7										
L →	2,6	2,8	3,8	4,8	5,8	6,8	7,8	8,8	9,8	10,3
1	3,20	3,00	2,65	2,40	2,30	2,10	1,73	1,65	1,55	1,45
2	3,20	3,20	2,60	2,30	2,09	1,88	1,73	1,55	1,45	1,27
3			2,60	2,30	1,95	1,70	1,53	1,41	1,26	1,17
4				2,25	1,75	1,55	1,35	1,30	1,18	1,03
5					1,50	1,30	1,15	1,12	1,00	0,96
6						1,10	1,10	1,04	0,93	0,90
7							0,80	0,80	0,80	0,80
8								0,65	0,64	0,64
9									0,53	0,52
9,45*										0,50
↑R	[ton]									

LC532_V100_0719_BP_GANCIO_J7

CRANE PERFORMANCE: J6										
L →	2,6	2,8	3,8	4,8	5,8	6,8	7,8	8,8	9,8	10,3
1	3,20	3,00	2,65	2,40	2,30	2,10	1,73	1,65	1,55	1,45
2	3,20	3,20	2,60	2,30	2,09	1,88	1,73	1,55	1,45	1,27
3			2,60	2,30	1,95	1,70	1,53	1,41	1,26	1,17
4				1,70	1,65	1,50	1,35	1,30	1,18	1,03
5					1,10	1,10	1,10	1,00	1,00	0,96
6						0,80	0,80	0,80	0,80	0,80
7							0,60	0,60	0,60	0,60
8								0,48	0,48	0,48
9									0,40	0,40
9,45*										0,36
↑R	[ton]									

LC532_V100_0719_BP_GANCIO_J6

*: Refers to hook configuration. Pulley configuration is 0,1m longer.

SPX532 - MAIN BOOM

						CRANE PERFORMANCE: J5
L →	2,6	2,8	3,8	4,8	5,8	
1	1,50	1,50	1,00	0,70	0,40	
2	1,20	1,20	0,70	0,50	0,40	
3			0,60	0,45	0,30	
4				0,35	0,28	
5					0,20	
↑R	[ton]					LC532_V100_0719_BP_GANCIO_J5

			CRANE PERFORMANCE: J1
L →	2,6	2,8	
1	0,40	0,40	
2		0,11	
↑R	[ton]		LC532_V100_0719_BP_GANCIO_J1

*: Refers to hook configuration. Pulley configuration is 0,1m longer.

SPX532 - JIB1000.2H1MX

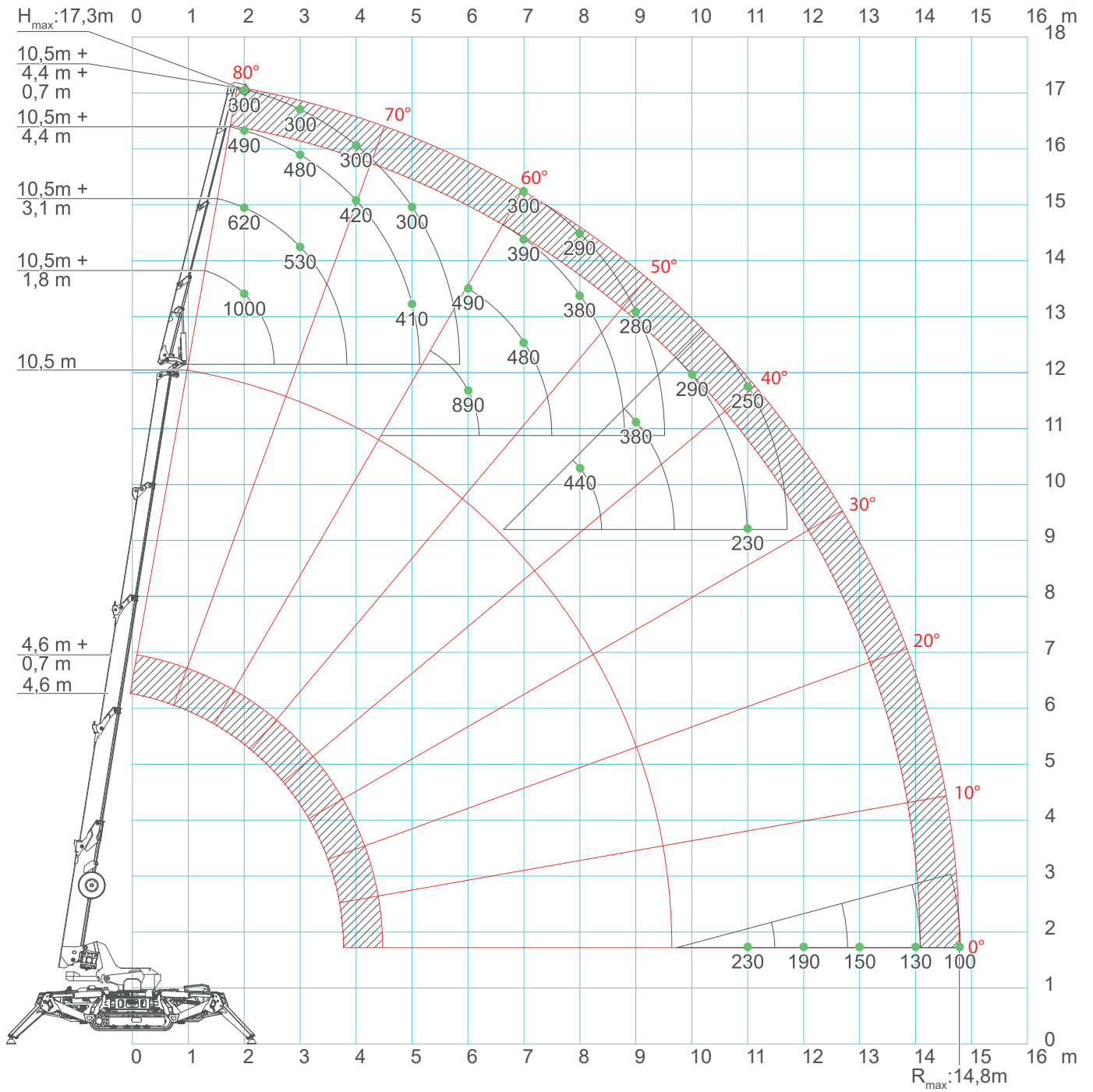

*: With manual extension on maximum weight is limited to 300kg.

SPX532 - JIB1000.2H1MX

		CRANE PERFORMANCE: J7			
$L_j \rightarrow$		1,9	3,1	4,4	5,1
2		1,00	0,62	0,49	0,30
3		1,00	0,53	0,48	0,30
4		1,00	0,51	0,42	0,30
5		1,00	0,5	0,41	0,30
6		0,89	0,49	0,40	0,30
7		0,67	0,48	0,39	0,30
8		0,44	0,40	0,38	0,29
9		0,38	0,38	0,34	0,28
10		0,29	0,29	0,29	0,25
11		0,23	0,23	0,23	0,23
12			0,19	0,19	0,19
13				0,15	0,15
14				0,14	0,13
14,8					0,10
$\uparrow R$	[ton]				

LC532_V100_0719_JIB1000_GANCIO_J7

		CRANE PERFORMANCE: J6			
$L_j \rightarrow$		1,9	3,1	4,4	5,1
2		1,00	0,54	0,45	0,30
3		1,00	0,50	0,43	0,30
4		1,00	0,48	0,36	0,30
5		0,80	0,43	0,33	0,29
6		0,59	0,40	0,30	0,28
7		0,42	0,38	0,29	0,27
8		0,30	0,30	0,28	0,26
9		0,20	0,20	0,20	0,20
10		0,14	0,14	0,14	0,14
11		0,11	0,11	0,11	0,11
11,2		0,11	0,11	0,11	0,11
$\uparrow R$	[ton]				

LC532_V100_0719_JIB1000_GANCIO_J6

SPX532 - JIB1000.2H1MX

		CRANE PERFORMANCE: J5			
L _J →		1,9	3,1	4,4	5,1
2		0,80	0,42	0,25	0,21
3		0,70	0,40	0,24	0,20
4		0,40	0,30	0,23	0,19
5		0,28	0,24	0,22	0,18
↑R	[ton]				

LC532_V100_0719_JIB1000_GANCIO_J5

		CRANE PERFORMANCE: J1
L _J →		1,9
2		0,10
3		0,10
4		0,10
↑R	[ton]	

LC532_V100_0719_JIB1000_GANCIO_J1

*: With manual extension on maximum weight is limited to 300kg.

SPX532 - JIB1200GX

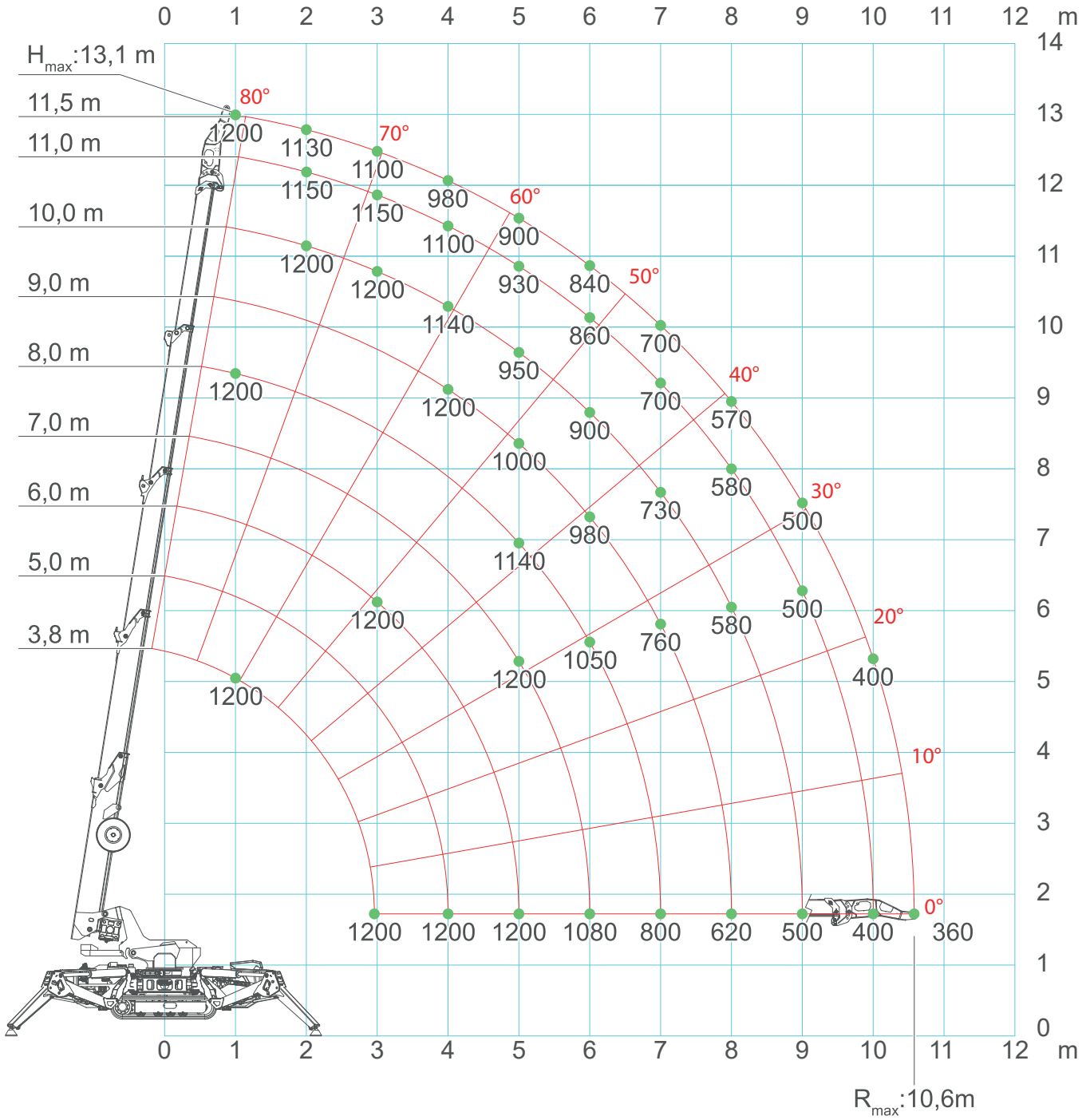

SPX532 - JIB1200GX

		CRANE PERFORMANCE: J7								
L →	2,8	4,0	5,0	6,0	7,0	8,0	9,0	10,0	10,5	
L+L _J →	3,8	5,0	6,0	7,0	8,0	9,0	10,0	11,0	11,5	
1	1,20	1,20	1,20	1,20	1,20	1,20	1,20	1,20	1,20	
2	1,20	1,20	1,20	1,20	1,20	1,20	1,20	1,15	1,13	
3	1,20	1,20	1,20	1,20	1,20	1,20	1,20	1,15	1,10	
4		1,20	1,20	1,20	1,20	1,20	1,14	1,10	0,98	
5			1,20	1,20	1,14	1,00	0,95	0,93	0,90	
6				1,08	1,05	0,98	0,90	0,86	0,84	
7					0,80	0,76	0,73	0,70	0,70	
8						0,62	0,58	0,58	0,57	
9							0,50	0,50	0,50	
10								0,40	0,40	
10,6									0,36	
↑R	[ton]									

LC532_V100_1119_JIB1200GX_GANCIO_J7

		CRANE PERFORMANCE: J6								
L →	2,8	4,0	5,0	6,0	7,0	8,0	9,0	10,0	10,5	
L+L _J →	3,8	5,0	6,0	7,0	8,0	9,0	10,0	11,0	11,5	
1	1,20	1,20	1,20	1,20	1,20	1,20	1,20	1,20	1,20	
2	1,20	1,20	1,20	1,20	1,20	1,20	1,20	1,15	1,13	
3	1,20	1,20	1,20	1,20	1,20	1,20	1,20	1,15	1,00	
4		1,20	1,20	1,20	1,20	1,20	1,14	1,10	0,98	
5			1,08	1,00	0,96	0,95	0,93	0,92	0,90	
6				0,78	0,75	0,71	0,68	0,62	0,60	
7					0,58	0,56	0,54	0,50	0,48	
8						0,47	0,44	0,42	0,40	
9							0,36	0,35	0,32	
10								0,29	0,28	
10,6									0,25	
↑R	[ton]									

LC532_V100_1119_JIB1200GX_GANCIO_J6

SPX532 - JIB1200GX

				CRANE PERFORMANCE: J5			
L →	2,8	4,0	5,0				
L+L _J →	3,8	5,0	6,0				
1	1,20	0,70	0,40				
2	1,11	0,42	0,36				
3	0,54	0,42	0,26				
4		0,28	0,22				
5			0,15				
↑R	[ton]						

LC532_V100_1119_JIB1200GX_GANCIO_J5

SPXS32CDH

ACCESSORIES SPX532CDH

OPTIONAL GRU

- YOUR COMPANY LAYOUT
- HA-SPX532
- VAI
- W800.6 + Bozzello 4T
- OM400.1
- EXT-312-424/29
- WT-429-532

JIB & ACCESSORI

- JIB1200GX
- JIB1000.2H1MX
- TK-JIB1000
- WUK-02.1

MOTORE ELETTRICO

- PP110-2.B
- PP220-2.B
- PP220-4.B
- PP400-6.B
- PP230-6.B

J-CONNECT

- J-CON
- J-CON-Y2
- 3YW-532

COLORE GRU

Braccio & Carter
Telaistica & Stabilizzatori

STANDARD

- PC01
- PC11
- RAL2004 RAL___ RAL___
- RAL7021 RAL7021 RAL___

SPXS32CL

OPTIONAL GRU



LAYOUT



HA-SPX532



VAI



W800.6 + Bozzello
4T



WUK-02.1

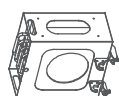

OM400.1

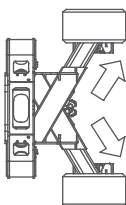

EXT-312-424/29



WT-429-532

JIB & ACCESSORI



JIB1200GX

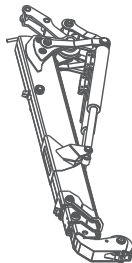

JIB1000.2H1MX

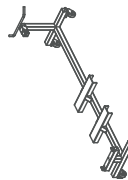

TK-JIB1000

CARICABATTERIE



BC3-110V60A



BC3-220V60A

COLORE GRU

Braccio & Carter

Telaistica & Stabilizzatori



STANDARD PC01 PC11

RAL2004 RAL___ RAL___

RAL7021 RAL7021 RAL___

J-CONNECT



J-CON

J-CON-Y2

3YW-532

ACCESSORIES FEATURES JIB1000.2H1MX

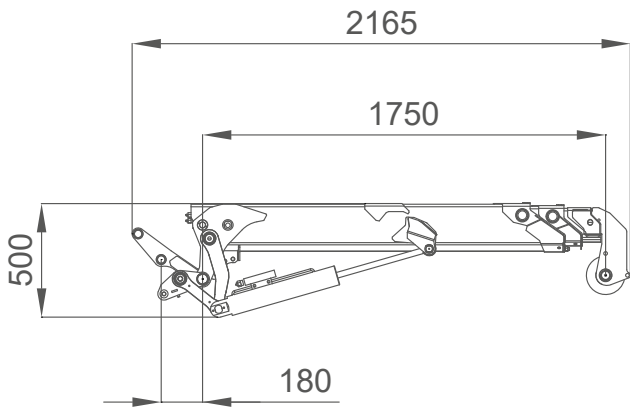
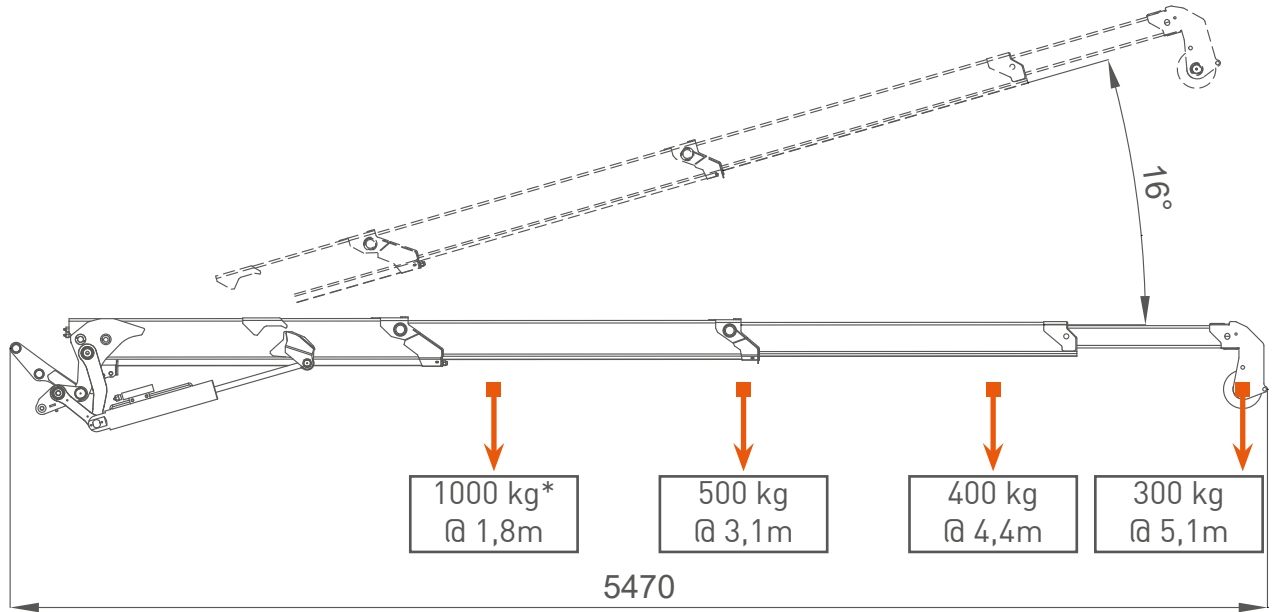





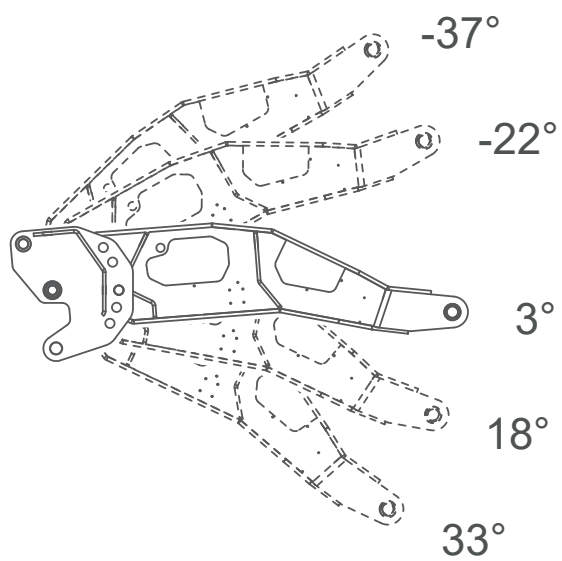
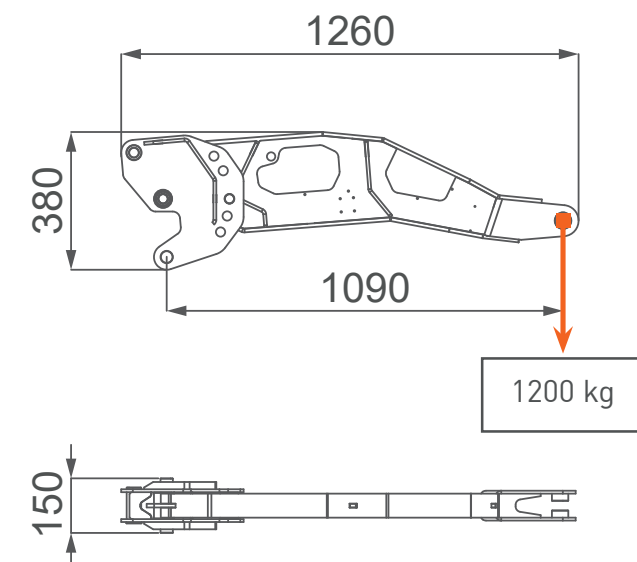















































*: Maximum capacity using hook, with winch this is limited to single fall winch capacity (800 kg).

JIB1200GX



SYMBOLS

	Weight		Engine		Boom Angle		Minipicker
	Counterweight		Diesel Fuel		Boom Length		Back Wheel Loading Point
	Crane		Petrol Fuel		Boom Radius		Front Wheel Loading Point
	Dimensions L x W x H		Tank		Jib on Board		Working Radius
	Stabilization Area		Power kW		Without Jib on Board		Stabilizing Bar
	Travel Speed		Battery		Jib Hook Radius		Standard EN
	Gradeability		Lithium Battery		Jib Length and Angle		Factory max. load
	Outrigger Load MAX		Powerpack AUX		Jib Length		Building site max. load
	Track Loading		Main Winch		Jib Radius		Maximum inclination of the machinery
	Outriggers Setup		Hookblock		Manipulator Length		Hydraulic oil
	Ext Tracks Width w		Slewing		Manipulator Radius		Winter Warm-up Kit
	Chart on Tracks		Slewing Locked		Number of vacuum pads		Horizontal Boom Angle
	Slope		Outriggers mats		Grabber		White Pads for Steel Tracks

REMARKS REFERRING TO LOAD CHART

- The load charts are calculated according to EN 13000.
- For the calculation of the load charts at least a wind speed of 9m/s (33km/h) and regarding the load a sail area of 1m² per ton load and a wind resistance coefficient of 1.2 on the load have been taken into account. For lifting of loads with large sail areas and/or high wind resistance coefficients the maximum wind speed as stated in the load charts has to be reduced.
- Lifting capacities are given in kilograms.
- The weight of the hook blocks and hooks is part of the load and therefore it must be deducted from the lifting capacities.
- Working radii are measured from the slewing centre.
- The lifting capacities given for the telescopic boom apply if the folding jib is removed.
- Subject to modification of lifting capacities.

**YOUR
JEKKO
DEALER**

EN All specifications and features herein described can be changed without prior advice. All indicated data are indicative only and are not binding as crane performs differently depending on its use. **IT** Tutte le caratteristiche e le specifiche descritte possono essere soggette a variazioni senza preavviso. Tutti i dati riportati sono forniti a puro titolo informativo e non sono impegnativi dal momento che le prestazioni della macchina variano in funzione dell'utilizzo. **DE** Unangekündigte Änderungen sämtlicher Eigenschaften und Daten sind möglich. Alle Angaben sind Richtwerte und nicht verbindlich da die Leistungen der Vorrichtung von deren Einsatz abhängen. **ES** Todas las características y las especificaciones aquí indicadas pueden ser sujetas a variaciones sin aviso. Se dan todos los datos aquí indicados como simples informaciones. No se consideran como vinculantes, dado que las prestaciones del maquinario pueden variar. **FR** Toutes les caractéristiques et le spécifications descriptives peut être sujet à variation sans préavis. Tout les données rapportés sont fournis à titre informatif et ne sont pas engager au moment que la prestation de la machine change en fonction de l'emploi.

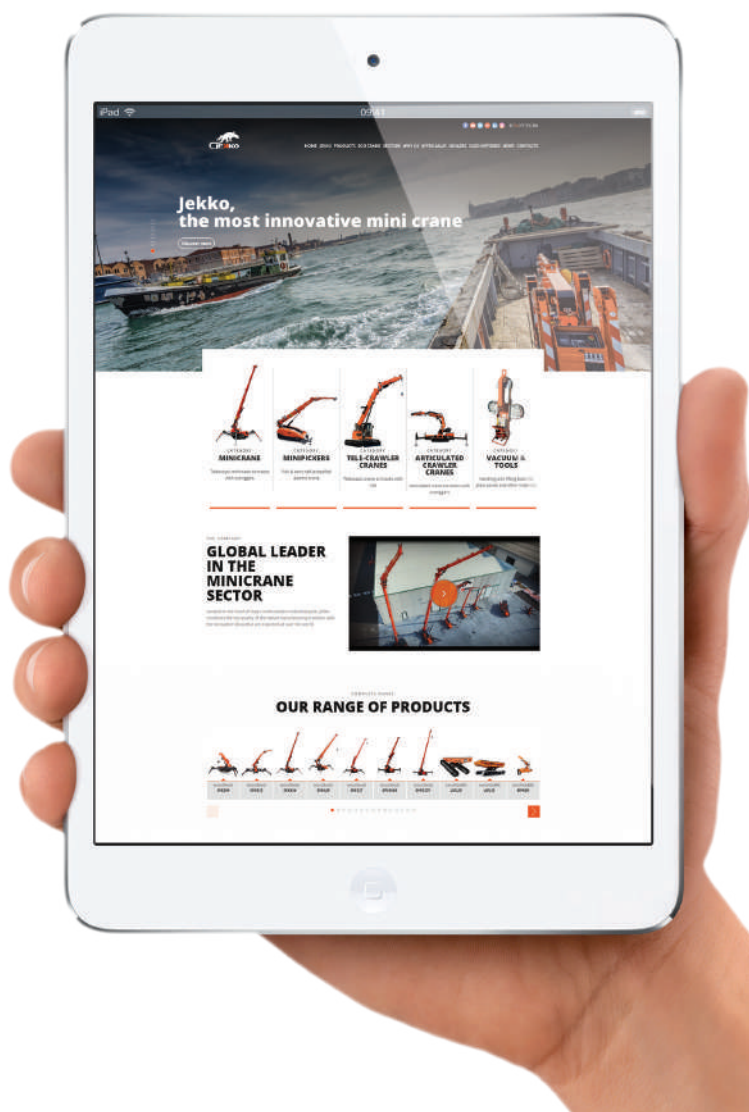

www.jekko-cranes.com

Visit jekko-cranes.com to keep in contact with us, discover all the latest news and find out technical details of all our products.



Jekko s.r.l.

Via Campardone, 1 - 31014 Colle Umberto (TV) - Italy
info@jekko.it - www.jekko-cranes.com

SERIAL NUMBER:

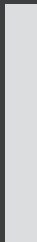

17.08.2020 | Rev.5